

雕刻杯墊

木頭雕刻

木藝產業

大溪木藝產業

河運

林本源家族

唐山木工匠

木藝衰退期

老屋拆遷

工廠機械化

人為因素

大溪木藝生態博物館

- 創立於2015年
- 全台首座以「生態」為名的博物館
- 無圍牆博物館
- 11座主要館舍





FISKBENSPARKETT

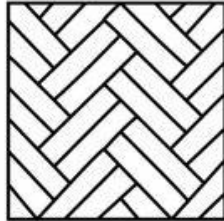

DUBBELT FISKBEN

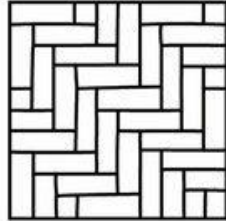

FISKBEN HALVFÖRBAND

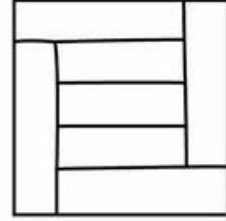

SWIRL

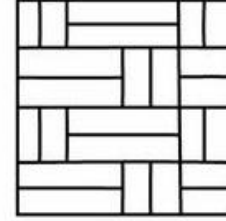

ABBOT

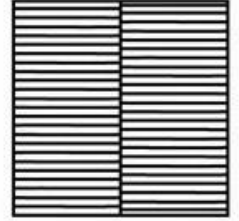

INDUSTRI-/
TÄNDSTICKSPARKETT

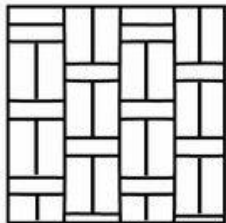

HOLLÄNDSKT FÖRBAND

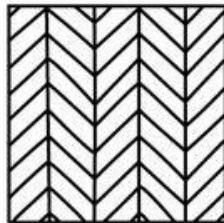

CHEVRON

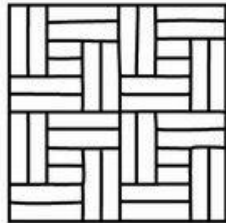

HADDON HALL

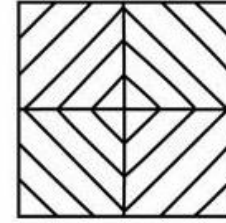

DIAMANT

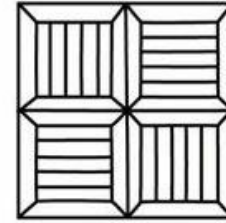

MONTICELLO

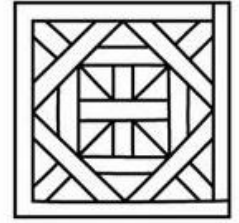

BORDEAUX

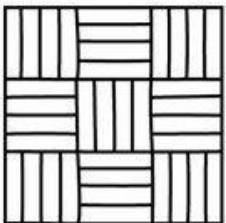

KUBB

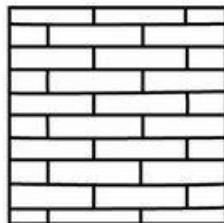

TEGELFÖRBAND

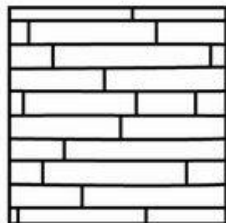

FALLANDE LÄNGDER

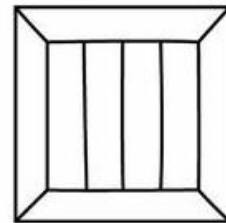

MOUNT VERNON

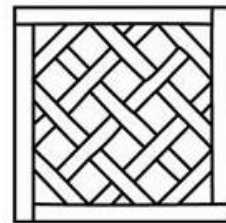

KUNGLIG PARKETT
/ VERSAILLES



STJÄRNPARKETT

trendenser

© Copyright Trendenser.se 2019
All rights reserved

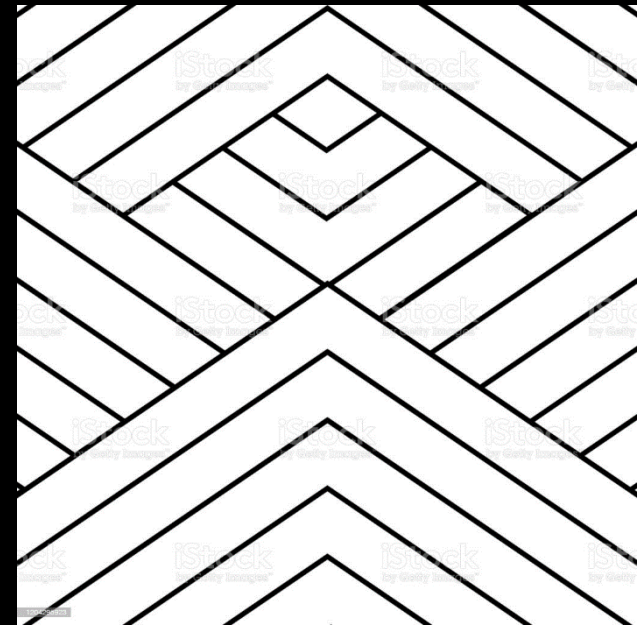
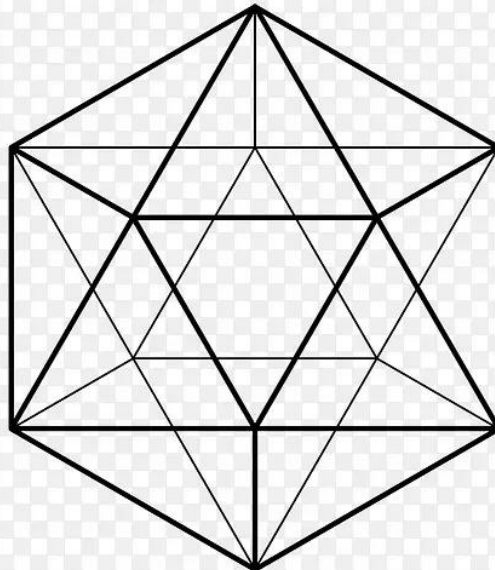
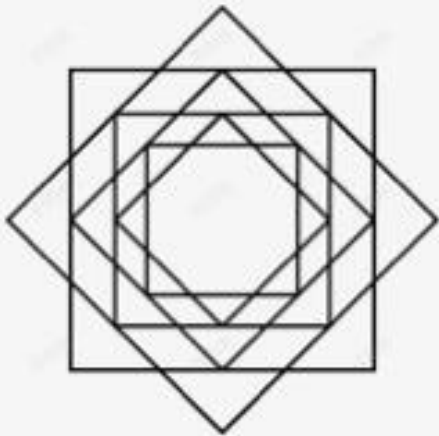
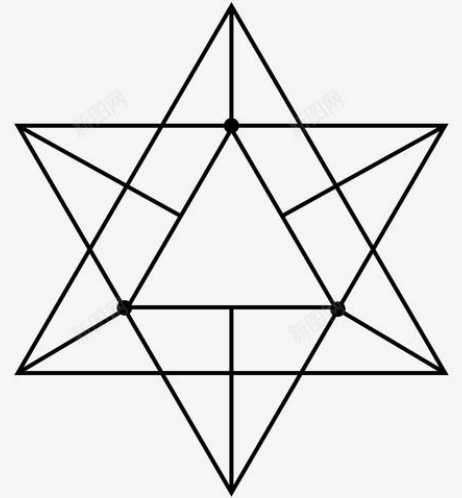
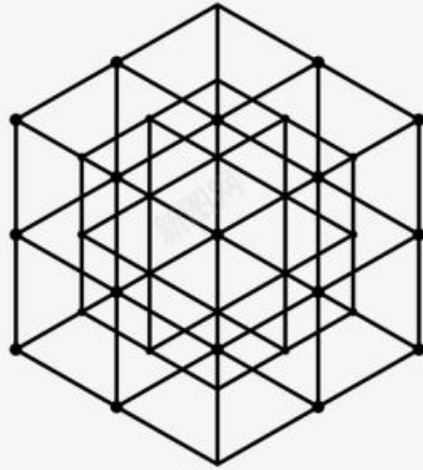
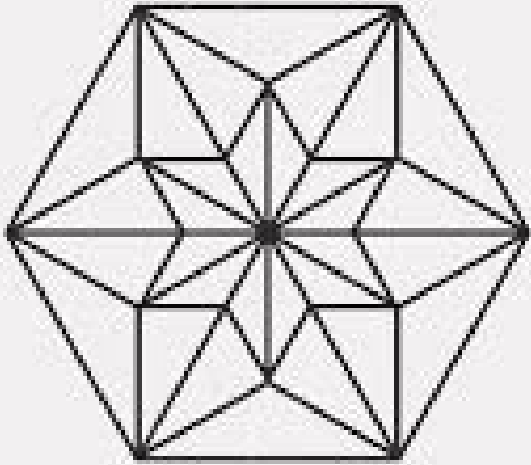

刀具選擇

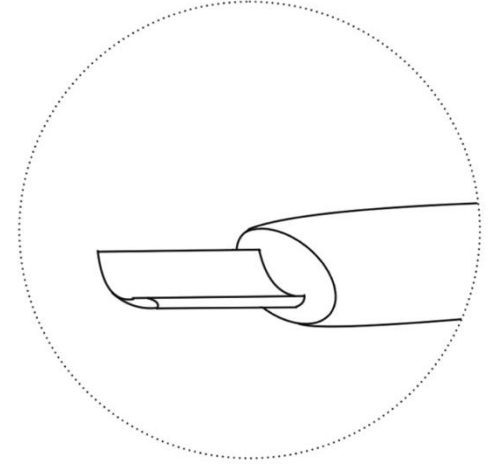
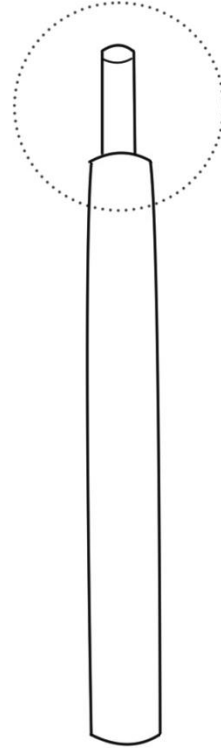
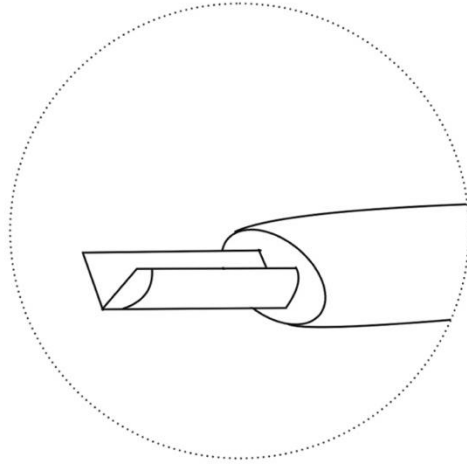
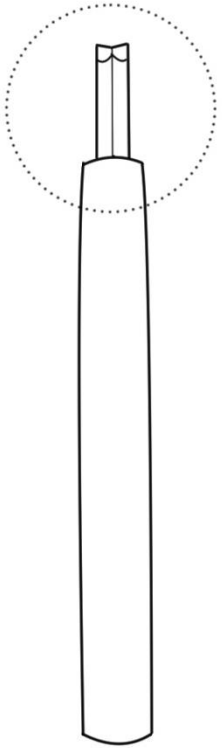

三角刀

丸刀

練習刻紋

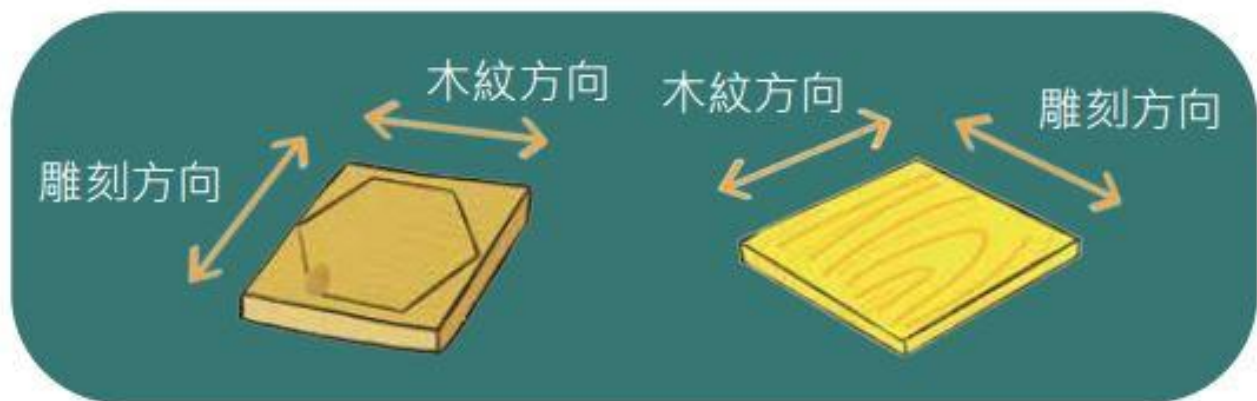

1

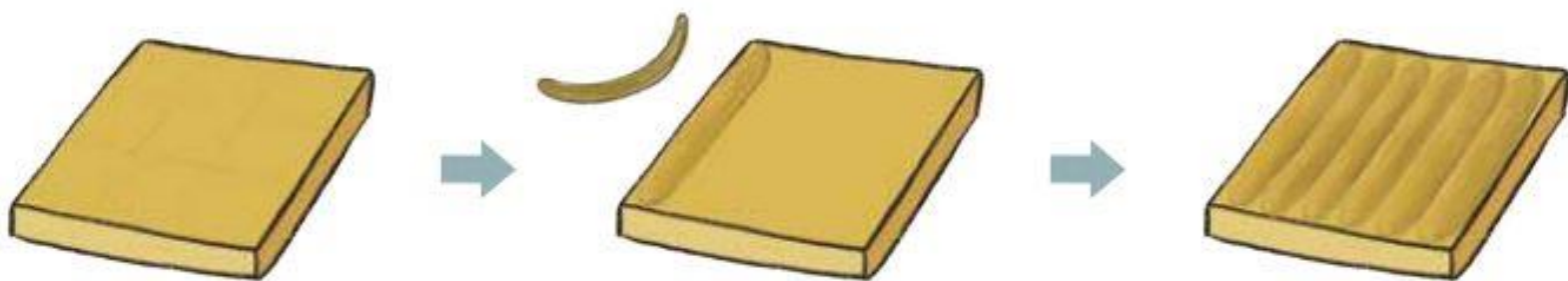

2



注意事項



!!!手不要在刀前面!!!

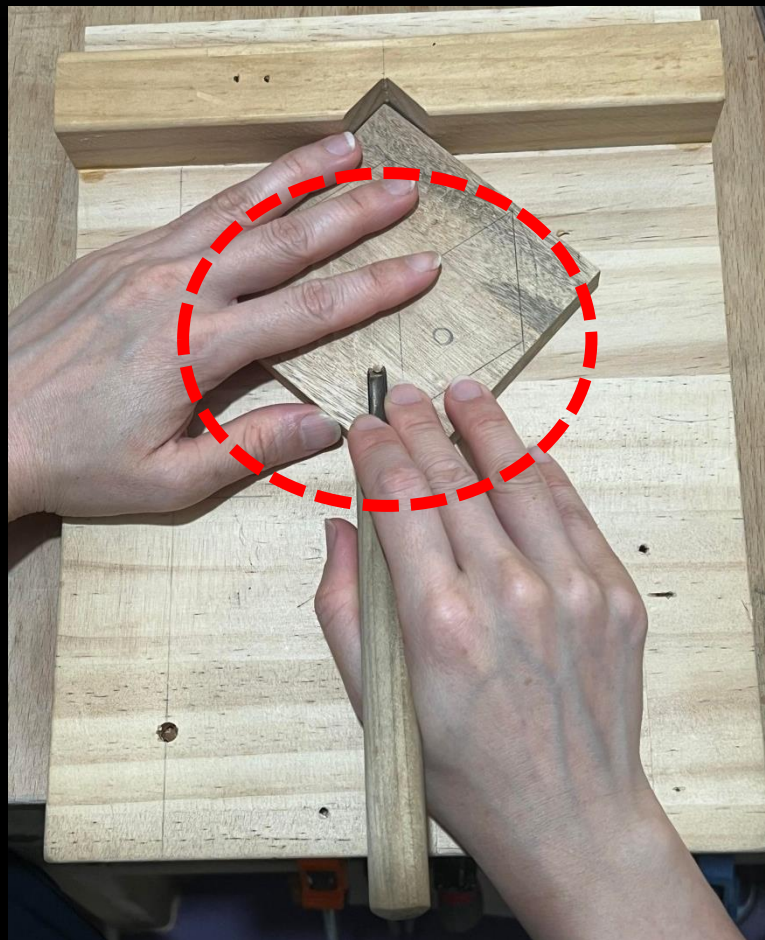

6-1



6-2



6-3



6-4

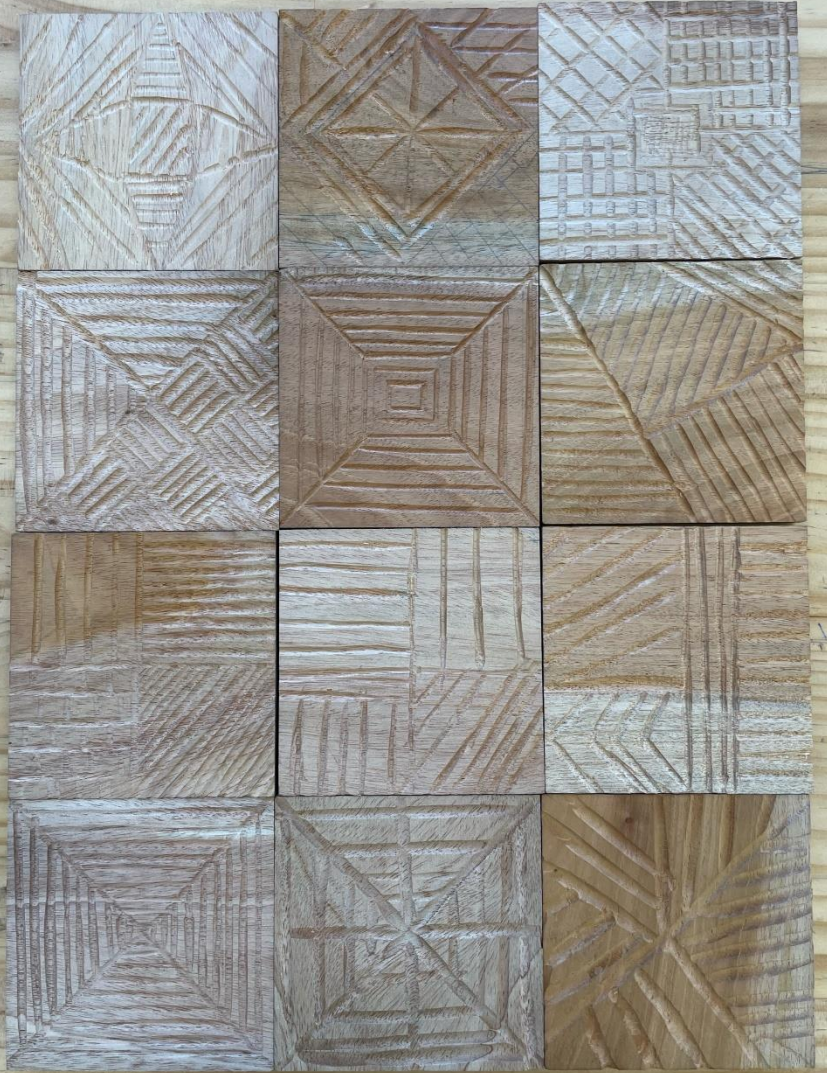

6-5

